



# 4K DVR Manual

Table of Contents	
Introduction	2
Includes	2
Quick Setup Guide	4
Features	4
Setup/Remote Control Diagram	5
DVR Menu Quick Start Guide	6
DVR Menu & Settings	7
LED Chart	11
Specifications	11
Frequently Asked Questions	12
Products	14
Warnings & Precautions	19
Warranty & Disclaimers	21



## Introduction | Zone Shield® & Xtreme Life® 4K

---

Thank you for purchasing your Zone Shield® or Xtreme Life® 4K hidden camera system. Before you get started, allow us to introduce you to some of the main features of your hidden camera. The Zone Shield® 4K DVR was designed as a standalone digital recording system for you to quickly deploy when you need to protect what matters. We incorporated a built in DVR recording system capable of 4K resolution, meaning it is high definition recording, a user friendly interface, and multiple recording options making the Zone Shield® 4K hidden camera the perfect solution. You can use Zone Shield as a simple motion activated system up to a fully customizable recording system. The choices are there to meet your specific recording requirements.

Xtreme Life® 4K was designed to be a long-life battery-operated hidden video camera and DVR. To accomplish extended battery life, your camera uses a technology known as PIR (Passive Infrared). You'll find the PIR sensor located next to or near your camera lens. The PIR sensor regulates the power to the internal video recording components and is the triggering mechanism that initiates recording. When there is no activity in range of the PIR sensor, the camera and the DVR will be powered down. When the sensor is triggered, it will send a signal to turn on the camera and begin recording almost instantly. The less activity, the longer the system will maintain battery life.

All of our SleuthGear® line of hidden cameras are designed and assembled in Nashville, TN USA backed by our 1 year warranty. Visit our website to see the full line of SleuthGear® hidden cameras at [www.mysleuthgear.com](http://www.mysleuthgear.com)

## Includes

---

- Zone Shield® or Xtreme Life® 4K DVR camera by SleuthGear®
- Battery Pack & USB charging cable (Xtreme Life® models)
- 32 GB Micro Memory Card
- DVR Remote Control
- DVR Video Output Cable
- Quick Setup Guide



## Compatible Memory Storage

For the camera to function properly, below memory card brands of class 6 and above are recommended:

- Apacer
- Toshiba
- SanDisk
- Kingston

For 64 & 128GB cards, the below memory card brands of class XCI or above are recommended:

- Toshiba
- Samsung EVO

## Memory Card Chart | *Estimated Recording Capacity in hours*

Video Resolution	Frame rate	1GB   hr	8GB   hr	16GB   hr	32GB   hr	64GB   hr	128GB   hr
<b>720P</b> 1280 x 720	30 fps	.34	2.72	5.44	10.88	21.76	43.52
	60 fps	.16	1.28	2.56	5.12	10.24	20.48
	120 fps	.14	1.12	2.24	4.48	8.96	17.92
<b>1080P</b> 1920 x 1080	30 fps	.15	1.20	2.40	4.80	9.60	19.20
	60 fps	.12	.96	1.92	3.84	7.68	15.36
<b>1296P</b> 2304 x 1296	30 fps	.11	.88	1.76	3.52	7.04	14.08
<b>2K</b> 2560 x 1440	30 fps	.08	.64	1.28	2.56	5.12	10.24
<b>4K</b> 2880 x 2160	24 fps	.09	.72	1.44	2.88	5.76	11.52

## Battery Pack Information | Xtreme Life® Models

The battery pack is to be charged with the provided USB cable inserted into either a USB port on a computer, or an A/C adapter (not included) with a USB connection similar to most modern smart phone chargers. While both methods are sufficient, the A/C adapter method will charge the battery more quickly. You can purchase additional battery packs using the part# **A1029** through the retail company you purchased your camera(s) from. If they do not have the part# listed on their website, you can call or email them and ask for an A1028 battery. Also be sure to check the Traveling with Batteries on page 20.



## Quick Setup Guide

---

1. Take the unit from the box and ensure you have received all included items (pg 3).
2. Open the device to insert the memory card into the memory card slot and connect the power supply or battery, turning it on after the connection is made.  
*For the Xtreme Life® models, charge the battery pack first ~10 hours for a full charge*
3. To confirm the device is ready, connect the provided video cable from the unit to your TV video input and create motion in front of the camera to see a live video feed and make a sample recording. Customize your settings in the Menu, such as Resolution, Record Time, Time & Date.
4. Your device is now ready to be placed in the area of desired surveillance.
5. Default recording setting is Motion Detection (Zone Shield®) or PIR detection (Xtreme Life®). Once the power is turned on and the device recognizes the memory card, the DVR will begin to record based on the default recording setting.  
*PIR Technology Note:* Each Xtreme Life® DVR has a built in PIR sensor that detects levels of infrared radiation, the use of which makes the battery life so long. Everything emits some level of radiation. The hotter an object is, the more radiation it emits. Changes in radiation levels are considered as motion by the DVR, which will then turn on and begin to record. The PIR sensor requires very little power, so the DVR will be off even though the PIR sensor is still detecting radiation. When the PIR detects a change in radiation, the DVR will turn on and begin to record. The DVR takes approximately 3 seconds to turn on and start recording.

## Features

---

- 4K Resolution: 2880x2160p
- Indoor & Outdoor Hidden video Surveillance System (select models)
- 120° Wide Angle Lens Captures More of Your Scene than Ever Before
- Long Lasting Rechargeable Battery using PIR Sensor Provides up to 90 Days of Standby (Xtreme Life® models)
- Night Vision – Hidden IR Lights Capture Video at Night (select models)
- Time & Date Stamped Files
- Digital CMOS Camera with 4K Image Sensor Provides Clear Captured Video
- Micro Memory Card for Portable, Transferable Storage – up to 128GB
- Easy 4K Video Playback Capable of viewing on Windows, Apple, and Other Platforms
- No visible wires (select models)
- Fast Start Up – From PIR Trigger to Record in 3 Seconds, Nothing Captures Video Faster
- 1 Year Manufacturer's Warranty

## Setup

### Remote Control Diagram



#### Playback Tip





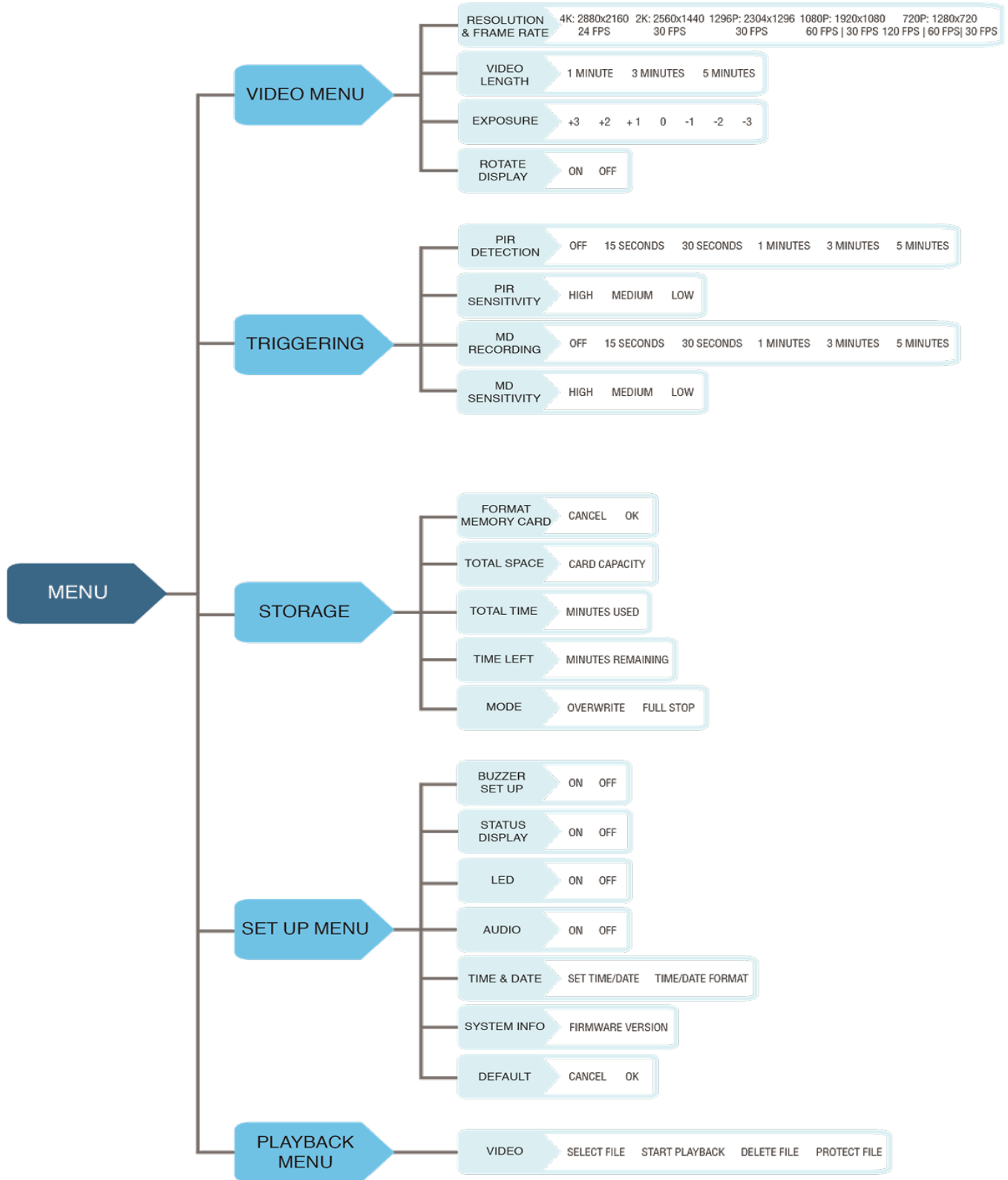

For best quality video and playback open files using your Memory Card in your computer.

Icon Button	Function	Description(s)
	Recording	Start/Stop Manual/Continuous Recording
	Lock/ Unlock	Remote control key lock/ unlock. Locks the buttons from accidental operation.
	Menu	Enter or Exit the settings menu
	Up/ Down Left/ Right	Menu navigation and settings changes
	Enter	Confirm selection
	N/A	Enter Playback Menu
	N/A	Pause Video Playback In Screen: <a href="#">Back Button</a>
	N/A	Stop Video Playback In Screen: <a href="#">Menu Button</a>
	N/A	Rewind Video Playback In Screen
	N/A	Fast Forward Video Playback In Screen: <a href="#">Right Arrow</a>
	N/A	Fast Rewind Video Playback In Screen: <a href="#">Left Arrow</a>
	LED	Turn DVR LED light indicators on or off (see page 11)
	Scheduling	Hours
	Scheduling	Select All   Single Days of the Week

## DVR Menu Quick Start Guide



## DVR Menu & Settings

- ▶ Connect your camera system to a monitor or TV using the cable included to begin customizing your DVR Settings.
- ▶ Press  on the remote to get into the On Screen Menu from the camera live view. From there you can modify the system settings.
- ▶ Press   to navigate within the menu and settings.
- ▶ Press  to select the setting.
- ▶ Press  to save and exit the current menu.
- ▶ Press  to advance through the menus, ending with an exit back to the camera live view.

## Video Menu

- ▶ For an estimated recording capacity by video quality and memory card capacity, refer to the chart on page 3.

▶ RESOLUTION & FRAME RATE: 4K: 2880x2160 24 FPS | 2K: 2560x1440 30 FPS | 1296P: 2304x1296 30 FPS | 1080P: 1920x1080 60 FPS | 30 FPS | 120 FPS | 720P: 1280x720 60 FPS | 30 FPS

▶ VIDEO LENGTH: 1 MINUTE | 3 MINUTES | 5 MINUTES

▶ EXPOSURE: +3 | +2 | +1 | 0 | -1 | -2 | -3

▶ ROTATE DISPLAY: ON | OFF

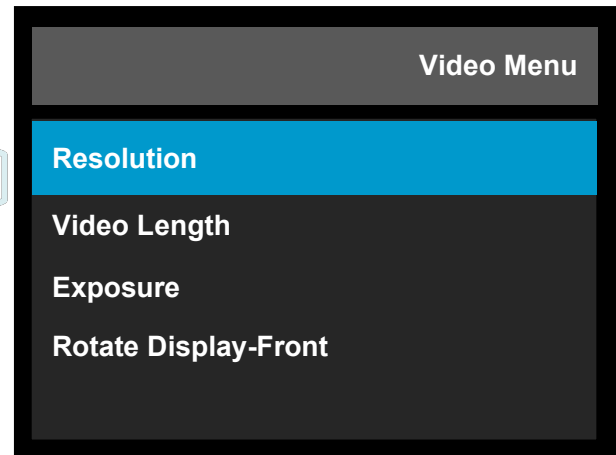

## Triggering

- ▶ **PIR Detection/M.D. Recording:** Depending on the model, the Triggering menu will have motion detection settings for either PIR (Xtreme Life) or Camera (Zone Shield) detection.
- ▶ **Manual/Continuous Recording:** If you wish to manually control recording instead, set either **PIR Detection** or **M.D. Recording** to **Off**, then exit all menus and use the Record button  to start & stop recording.



**OR**

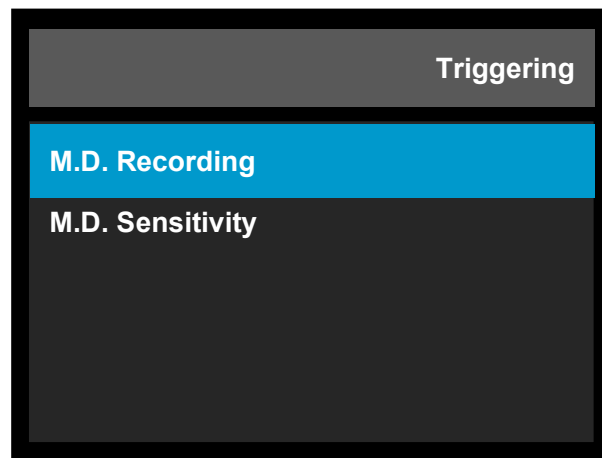
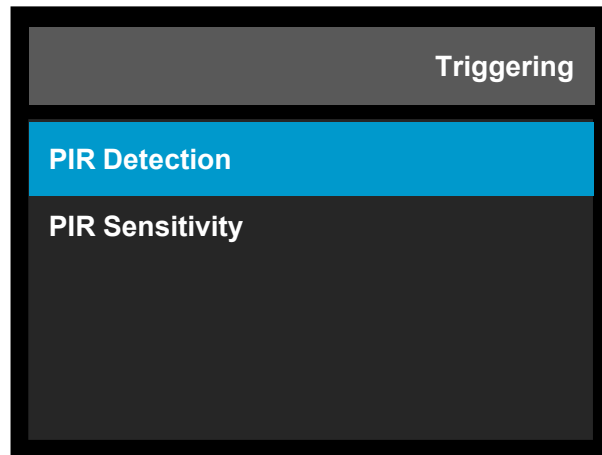



## Storage



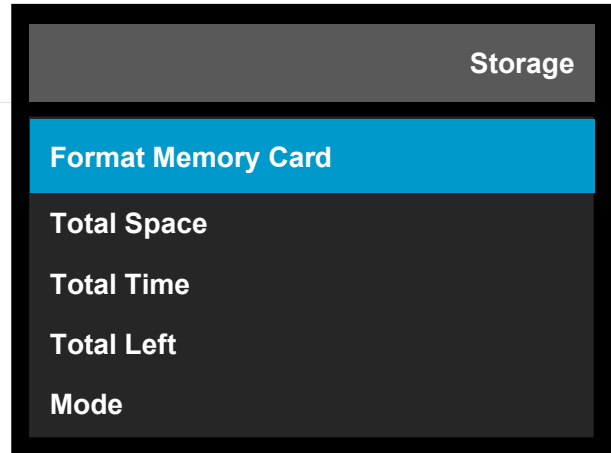
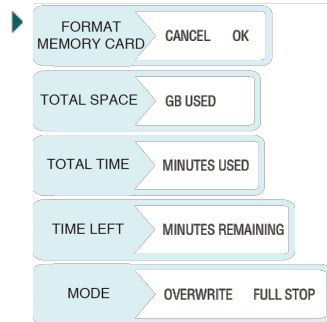

- ▶ **Total Space, Total Time and Time Left** will be calculated automatically

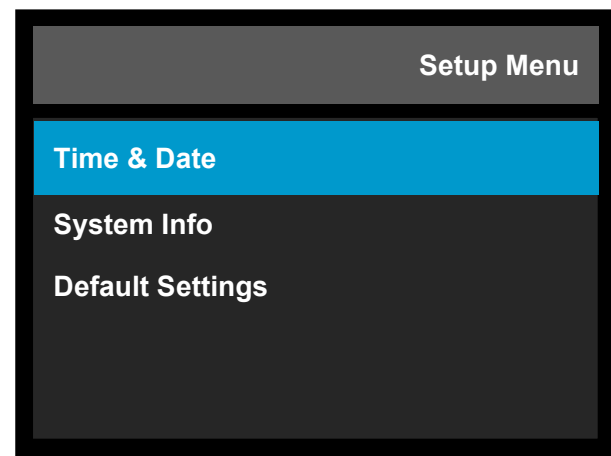
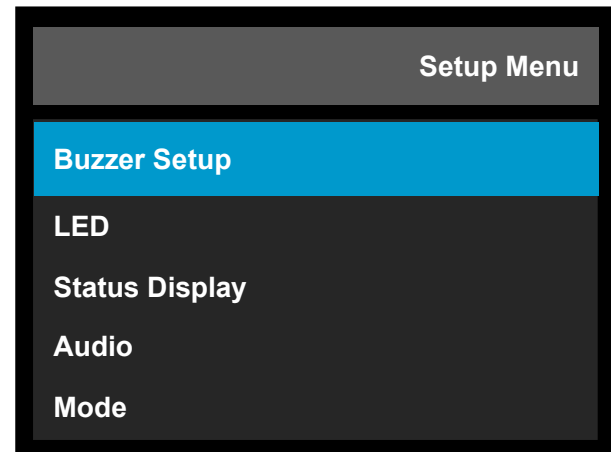
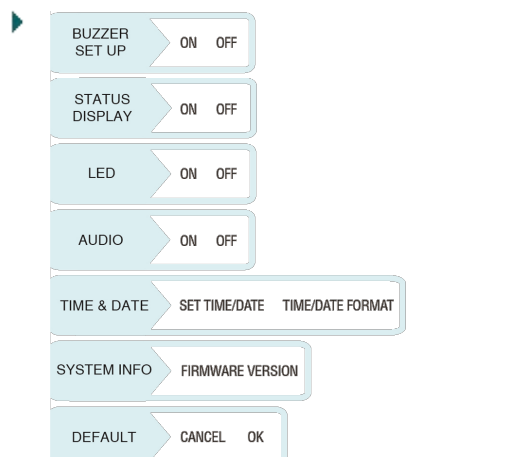

## Set Up Menu





- ▶ **Buzzer Setup:** Turns the confirmation sound on or off.
- ▶ **Status Display:** Turns the live view On-Screen-Display on or off. The OSD does not show on recorded files.
- ▶ **Audio:** Option available on Law Enforcement and Export models only!

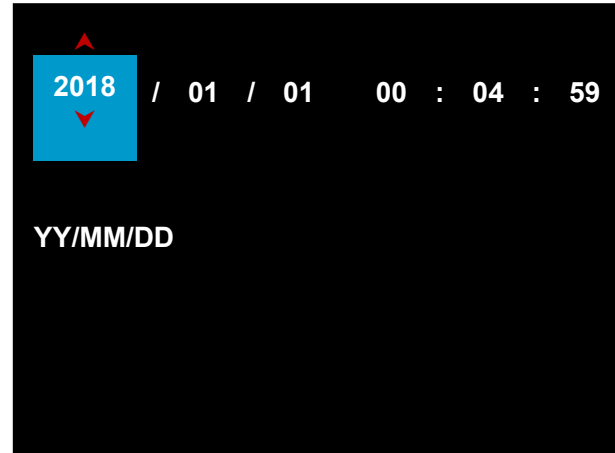

- ▶ In the **Time & Date** setting, press   to navigate and press   to change the setting.
- ▶ **Date & Time format options:** YYYY/MM/DD, MM/DD/YYYY, or DD/MM/YYYY



## Playback Menu

- ▶ For live view, press  to enter the Playback Menu directly.
- ▶ Press   to navigate the files.
- ▶ Press  to enter the selected clip.
- ▶ On Screen functions for live playback. *\*Best way to View or Playback files is from the memory card on your computer.*

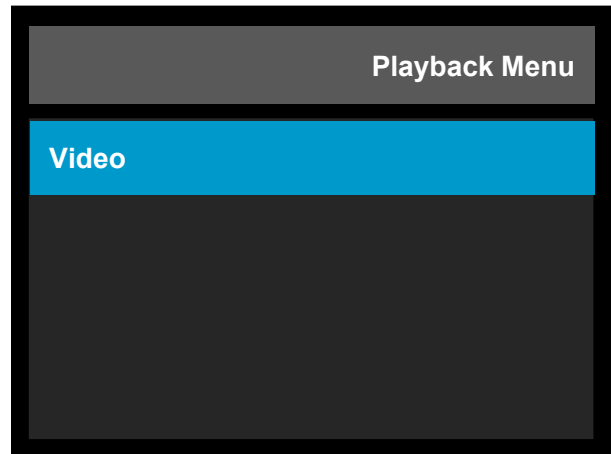



## LED Chart

Power Indicator (Red LED)	 <b>On</b> Power on	 <b>Blinking</b> Recording	 <b>Off</b> Power off
------------------------------	---	--	---

## Specifications

Operation Temperature	-20°C~60°C (-4°F~140°F)
Video Resolution	4K [2880x2160]   2K [2560x1440]   1296P [2304x1296] 1080P [1920x1080]   720P [1280x720]
Video Format	MPEG4
Video Compression	H.264
Video Recording Schedule	PIR   Motion Detection   Continuous
Recording Frame Rate	24, 30, 60, 120 fps
Playback	On Screen [TV or Monitor] via DVR or Computer
Recording Storage	Micro Memory Card up to 128GB
Audio Recording	Optional (Law Enforcement/Export only)
Audio Output	Analog 1 Channel Output
Power Supply	5V D/C
Power Consumption (while recording)	Nominal 2.0W
Video Storage Mode	Full-stop or Overwrite
<b>Additional Specifications for Xtreme Life® product line only</b>	
PIR Video Recording Schedule	PIR   Continuous   Off
PIR Post Recording	Off, 30 Seconds, 1 Minute, 3 Minutes, 5 Minutes
Battery Life	Up to 90 days on standby / 16 hours continuous



## Frequently Asked Questions

---

### Q. How do I playback my video?

A. From the device, go to Playback Menu to view on your television, using on screen playback functions. You must have the output cable plugged in to your television, then select the proper input on your television to display the video from the unit. Or remove the memory card from the device and open up video files on your computer.

### Q. What media player software should I use to playback the recorded files?

A. The recorded files are in the .MPEG4 format, which is able to be played back on software such as Windows Media Player, MAC Quick Time Player and others often pre-installed on a personal computer. If you are having trouble with playback, try downloadable software such as the free open-source player VLC (videolan.org).

### Q. What happens if there are no video files on my memory card?

A. For Xtreme Life® models, the unit is set to PIR detection by default. If you have had no activity, you will not have no video files. For all models, please make sure there is power to the camera and your memory card is inserted into the memory card slot, and make sure to do a test recording with the device connected to your television.

### Q. Why can't I find my recorded files on my memory card?

A. To directly access your files, you need to remove the memory card from your device and access it from a PC or MAC. If the card is not instantly recognized, go to My Computer, This PC or Finder, and search for devices listed as Removable Storage or drives listed as Removable Disk. Recorded files are saved inside folders on the memory card. As with almost all video and photo cameras, the files are saved inside a folder named DVR. On this camera, the files are actually saved within folders that end in the digits for month and day, found inside the DVR folder. Within those dated folders, the files are saved in numerical sequence of their occurrence.

### Q. How do I reset my unit back to the way I got it?

A. Restoring the unit to its factory default settings can be done in the Set Up Menu > Default Settings > OK. See page 10. \*Note: this will remove any adjustments to settings you have made.

### Q. Why does my device quickly turn off when trying to access the Menu?

A. Any of the following conditions will automatically put the device into sleep mode (Xtreme Life® models only):

- No memory card is inserted
- Completely exiting the Menu
- Upon pressing the Menu to exit the Playback mode
- Memory card is full and Storage mode is set to Full-Stop
- Recording Schedule is set to "None"



### **Q. What size memory cards can I use in this camera?**

**A.** Most memory cards, of up to and including 128GB capacity (class 6 or higher), are supported. If a memory card does not appear to work, try removing and formatting the memory card using a computer before trying it in the camera again.

### **Q. Why did I not get a recording when I know there was motion in front of the camera?**

**A.** The motion was not detected because it was too little, too quick or too far away. Make test recordings to discover the limits of detection in your given placement and environment. Check Motion Sensitivity Settings.

### **Q. Why will my video file not play or the file is corrupted?**

**A.** If the camera is not properly powered down prior to removing the memory card, the files on the memory card, or the memory card itself, may become corrupted. Make sure to always properly power down the camera before attempting to remove the memory card.

### **Q. Why do I only see part of my desired surveillance target?**

**A.** Placement of any camera is a very important step in setup. Be sure to make test recordings of the desired area of surveillance prior to final setup to ensure the camera can perform as desired in your given environment. This should not only include what area can be captured by video, but also testing the ability to properly trigger recording in the area if using Motion Detection mode or PIR detection.

### **Q. How do I restart or reboot my camera?**

**A.** You can reboot your camera by disconnecting it from the power supply. For Zone Shield®, this will be an A/C adapter. For Xtreme Life®, this will be the battery pack. Then simply re-connect the power supply and the camera will power back on. Be sure that the camera is not recording while powering down, as this can corrupt the video file it was trying to record or corrupt the whole memory card.

**For units that have Night Vision (IRs); not all units come with this option, please check your receipt:**

### **Q. Why are my Night Vision images not that bright?**

**A.** Covert placement of the camera and IR sensor affect image quality in each individual product form. Move the unit to different locations to test the video quality. You will experience pixilation with any night vision camera. SleuthGear® strives to maintain a balance between creating a reliable hidden camera and recording in extreme low light conditions.

**While SleuthGear® makes a concerted effort to test Night Vision products in different low-light situations; we cannot replicate every possible lighting environment at a customer's location.**

**Products**

**Wall Clock**

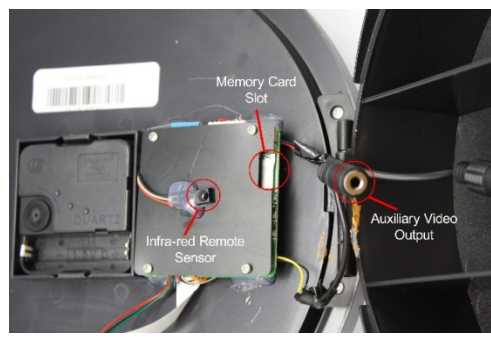

**Smoke Detector**

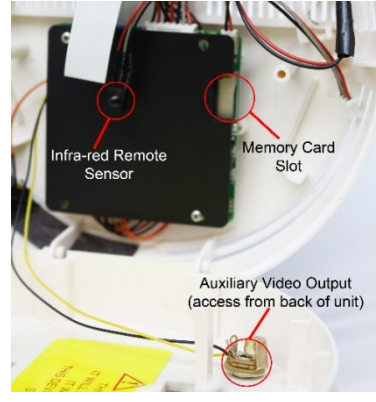

**Rock**

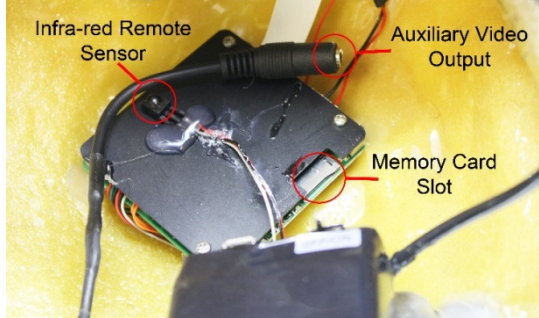

**Clock Radio**

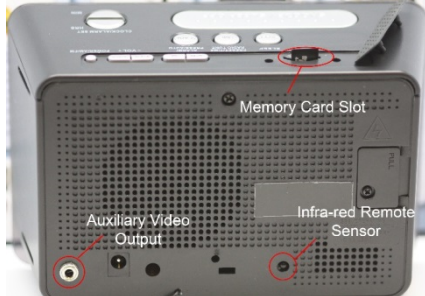



**Bluetooth Speaker**

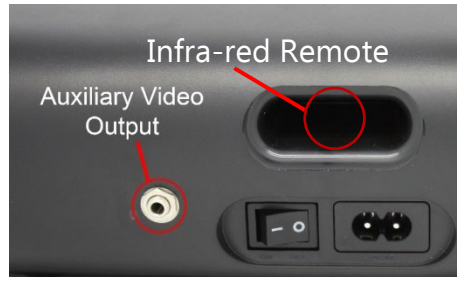
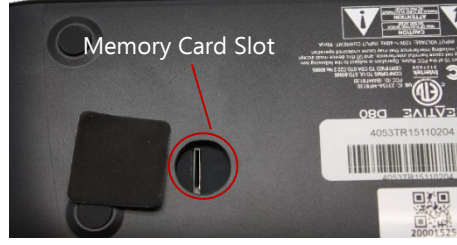
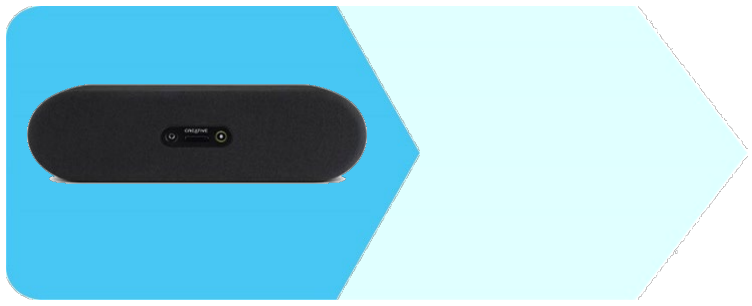

**Electrical Box**

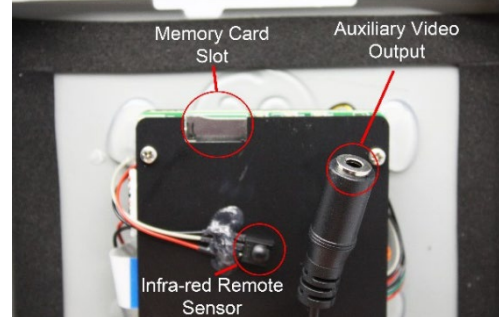
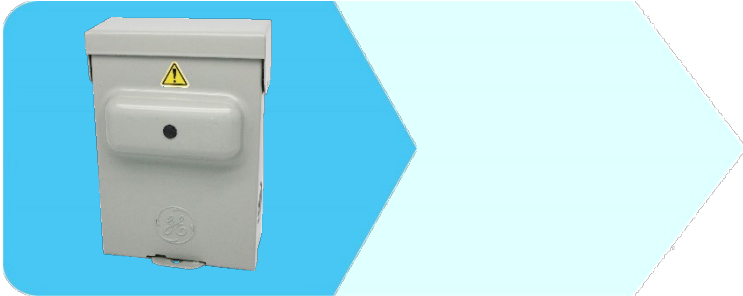

**Outdoor Power Strip**

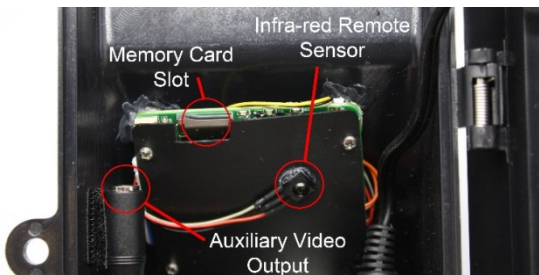
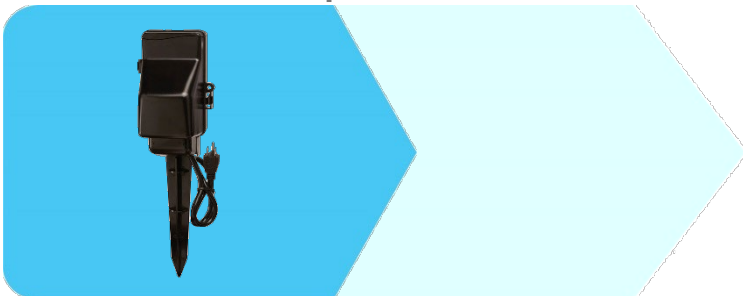

**Air Freshener**

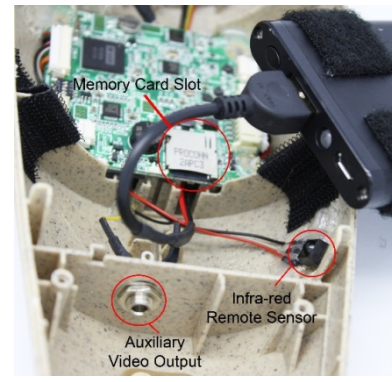
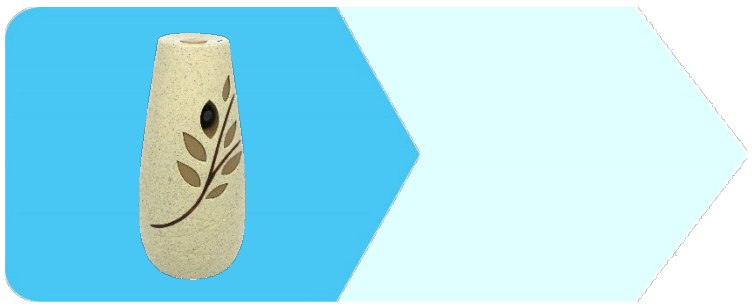

**Plant**

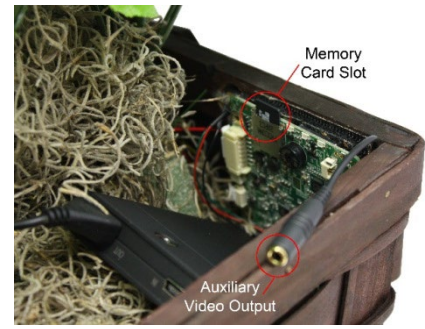

**Teddy Bear**

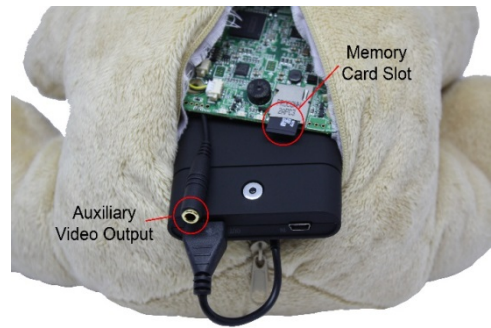
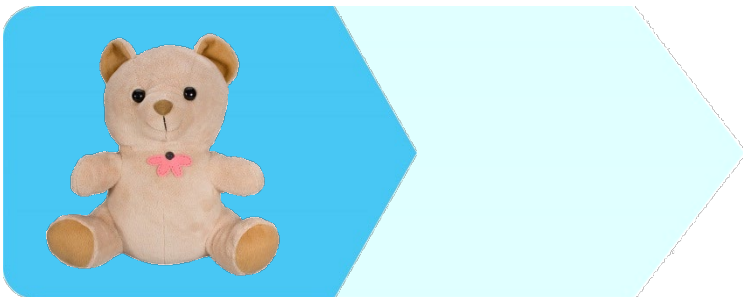

**Mantel Clock**

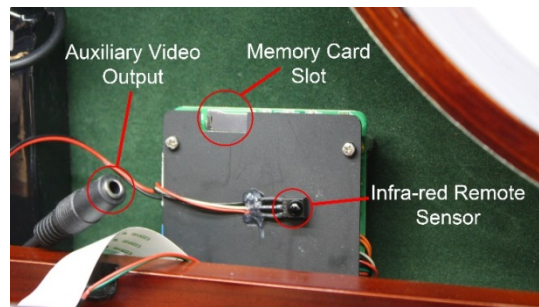
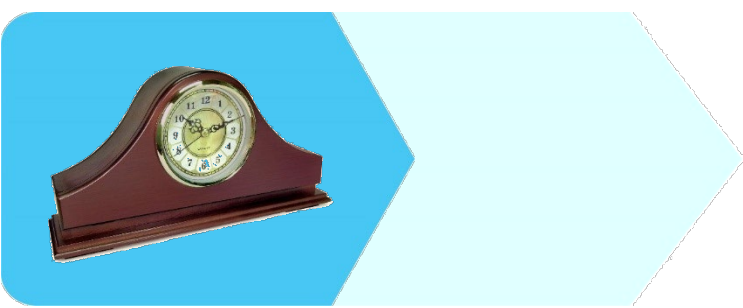

**DVD Player**





**Bird Feeder**

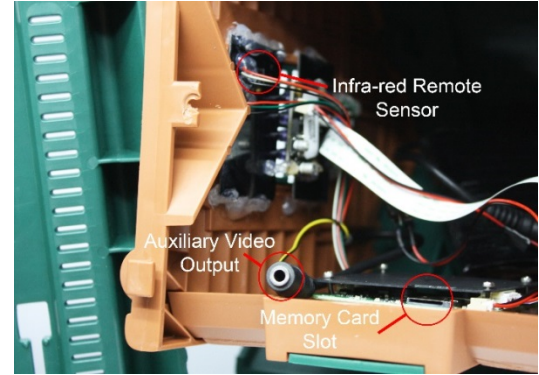
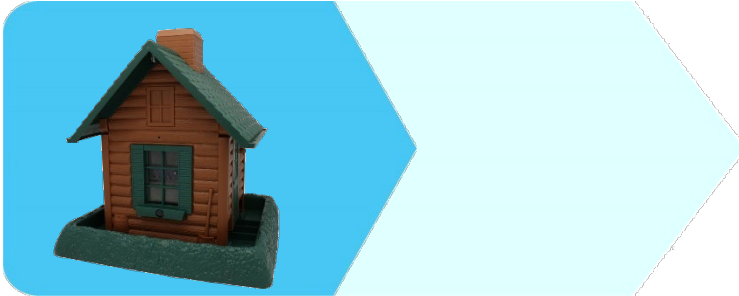

**Oscillating Fan**

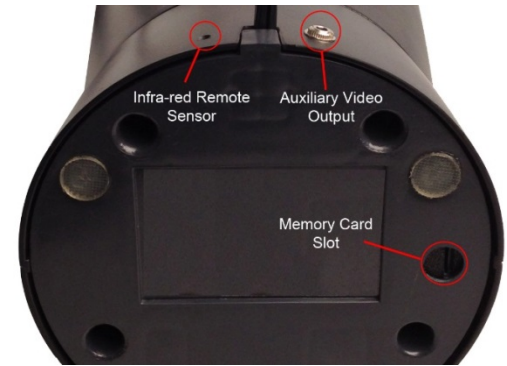
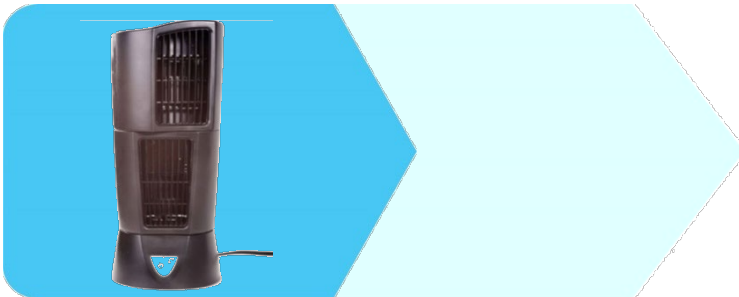

**Air Purifier**

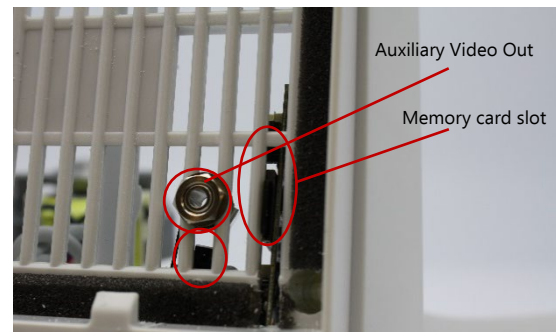

**Rectangle Clock**

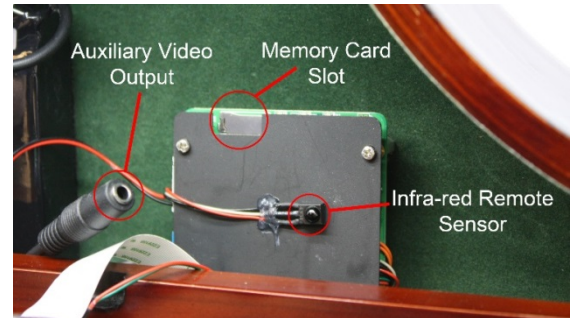
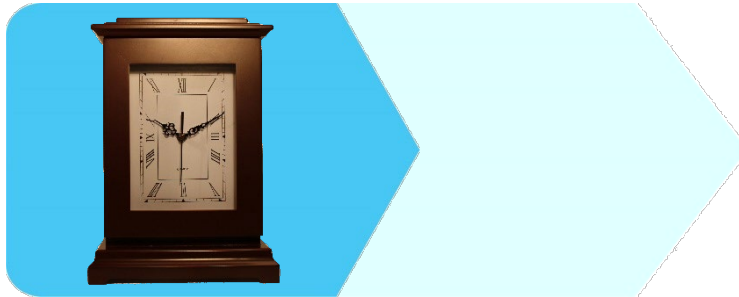

**LED Desk Lamp**

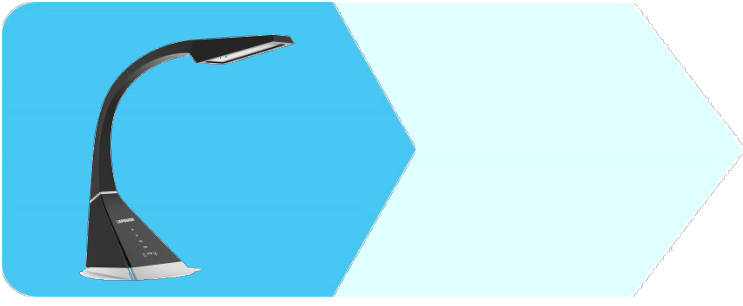

**Room Freshener**

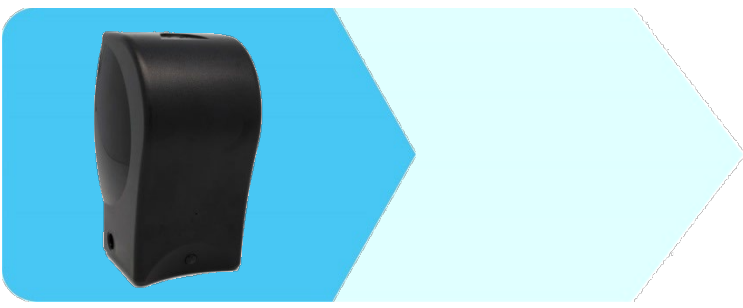

**Cable Box**

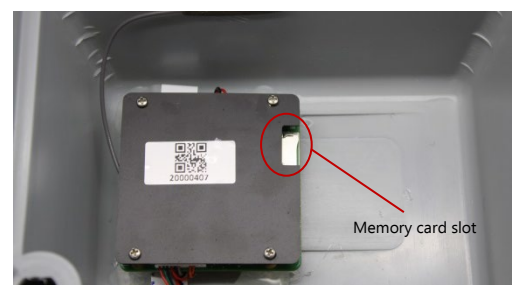

**Night Vision Room Freshener**

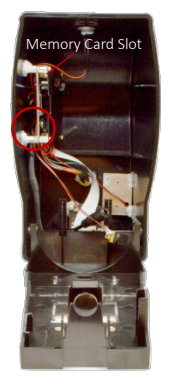

### Zen Air Freshener

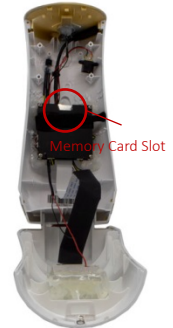
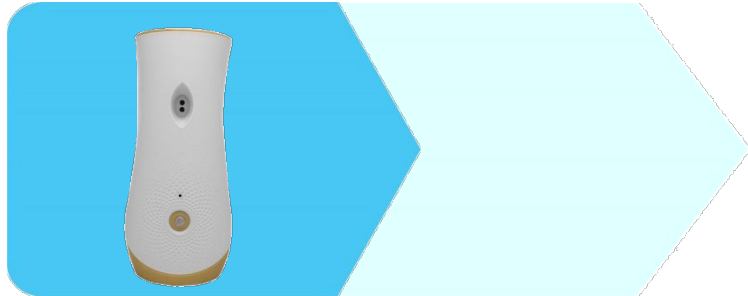

### Night Vision Exit Sign

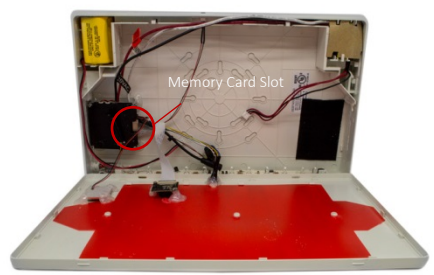
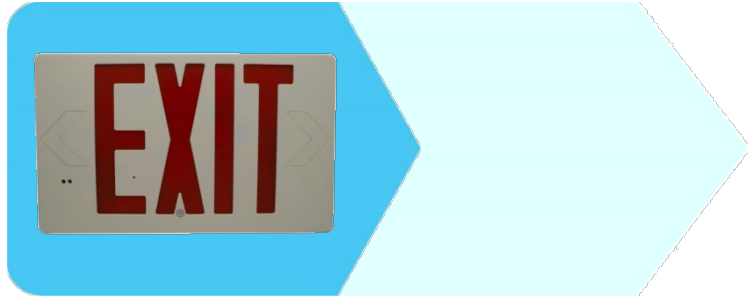

### Night Vision Indoor Cable Box

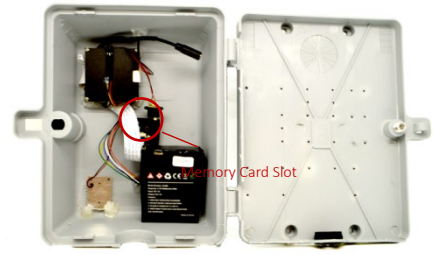

### Tree Stump

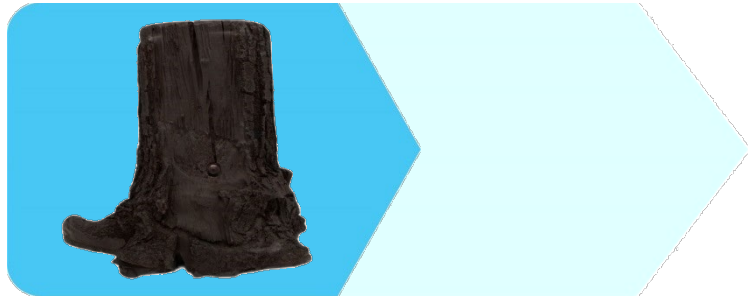

## Warnings & Precautions



**Do not open/modify** the device, as it may cause damage to the unit and void the Warranty. For internal repairs, consult your dealer or an Authorized Service Center.



**Do not use** any accessories or power supplies other than what comes with the device; otherwise it could void the warranty.



**Protect from humidity.** Do not put it in water and be careful to protect it from rain, sea water, or high humidity environment. Do not operate the unit near a bath tub, shower, sink, swimming pool, etc.



**Protect from high temperatures.** To avoid damage or mis-operation of the device, only use in temperature of 0 ~ +40°C(32 ~ 104°F).



**Do not bring** the device suddenly from a hot to a cold place, or vice versa. This may cause damage to the inside of the unit by creating condensation.



### EU Environmental Protection

The symbol of crossed-out garbage shows that this product should not be treated as household waste, as it falls into the category of electric/electronic equipment for recycling. This electronic device should not be disposed of in regular trash. We strongly advise you to contact your local authority for proper disposal of this product.



## TRAVELING WITH BATTERIES

---

Batteries and battery-powered devices are safe to travel with if you follow these simple guidelines from the U.S. Department of Transportation:

- If possible, keep spare batteries in the original retail packaging, to prevent unintentional activation or short-circuiting.
- If an on/off switch is present, be sure the switch is in the OFF POSITION. **DO NOT TRANSPORT BATTERY WHILE ACTIVATED.**
- For loose batteries, place a strip of insulated tape across the battery's contacts or place each battery in its own protective case, plastic bag or package to protect them from contact with metal objects, such as coins, keys or jewelry. **CONTACT WITH METAL OBJECTS CAN SHORT-CIRCUIT THE BATTERY LEADING TO HIGH HEAT, LEAKAGE OR RUPTURE, RESULTING IN PERSONAL INJURY OR PROPERTY DAMAGE.**
- Take steps to prevent crushing, puncturing or putting a high degree of pressure on the battery, as this can cause an internal short-circuit, resulting in overheating.
- **DON'T** store batteries or battery-powered devices in hot places — elevated temperatures can lead to capacity loss, leakage or rupture.
- **DON'T** mix old and new batteries, or mix different types or makes of batteries. This can cause leakage or rupture, resulting in personal injury or property damage.
- **DON'T** give batteries to young children.

Per the U.S. Department of Transportation, “batteries pose little risk contained in the devices they power and that taking the battery out of the device does not enhance safety.”

For the latest in battery and battery-powered device transportation, please visit <http://safetravel.dot.gov/>.

For additional information contact: [support@kjbsecurity.com](mailto:support@kjbsecurity.com) or 1-800-590-4272. Outside the U.S. call 615-620-1370.





## Manufacturer's Limited Warranty

Manufacturer warrants all Covert Video and SleuthGear® Hidden Video Products (Product) assembled and sold by Manufacturer to be free of defects in material and workmanship, subject to the following conditions. The duration of Manufacturer's warranty with respect to the Product is limited to one (1) year from the date of sale to the original consumer purchaser only for Products delivered within the fifty (50) states of the United States, District of Columbia, or the possessions and territories of the United States

**No other express warranties are made with respect to any Product. All implied warranties, including warranties of merchantability and fitness for a particular purpose are limited to the warranty period set forth above. This warranty is not transferable and applies only to the original consumer purchaser of the Product.**

Manufacturer will, as its sole obligation under this warranty, replace or repair, at its option, any Product that does not conform to this warranty. Under no circumstances will the Manufacturer issue credit or give a refund for Product covered by this warranty. Furthermore, under no circumstances will Manufacturer be liable for any incidental or consequential damages under this warranty or any implied warranties.

### What is not covered:

This limited warranty does not cover Products that in Manufacturer's judgment have damage resulting from any (i) deviation from Manufacturer's operating instructions as printed in Manufacturer's catalog or on any packaging, labels or other literature provided with a Product, (ii) installation of a Product in a manner which is inconsistent with Manufacturer's written instructions, (iii) alteration, modification of or tampering with a Product, (iv) misuse, (v) neglect, (vi) abuse, (vii) accident, (viii) power surge, static electricity or other electrical discharge, (ix) normal wear and tear, (x) commercial use, (xi) service by anyone other than a Manufacturer authorized repair facility, or (xii) other improper application, installation or operation of the Product. Or, (xiii) have been purchased from inventory clearance or liquidation sales or other sales in which Manufacturer expressly disclaims its warranty obligation pertaining to the Product.

### How you (the Customer) can get service:

To obtain warranty service during the warranty period, you must return the defective Product with the original receipt to the original place of purchase. Contact them for return instructions. If warranty service is needed at any time during the warranty period, the purchaser will be required to furnish a sales receipt/proof of purchase indicating the date of purchase, amount paid and place of purchase. Customers who fail to provide such proof of purchase will be charged for the repair of any Product.

### How state law relates to the warranty:

Some states do not allow limitations on how long implied warranties last, or the exclusion or the limitation of incidental or consequential damages. So the above limitations or exclusions may not apply to you. This warranty gives you specific legal rights. You may also have other rights that may vary from state to state.

**NO PERSON IS AUTHORIZED BY MANUFACTURER TO MODIFY OR ADD TO THIS LIMITED WARRANTY.**

**For warranty information on Products delivered outside the United States please contact the original place of purchase.**

DO NOT ATTEMPT TO RETURN PRODUCT TO ORIGINAL MANUFACTURER, AS THIS PRODUCT HAS BEEN MODIFIED AND IS NO LONGER SUBJECT TO ORIGINAL MANUFACTURER'S WARRANTY. IN THE CASE OF A DEFECTIVE PRODUCT, CONTACT PLACE OF PURCHASE FOR RETURN PROCEDURE.

IT IS THE USER'S RESPONSIBILITY TO ENSURE THAT THIS EQUIPMENT IS USED IN ACCORDANCE WITH THE LAW(S) OF THE JURISDICTION IN WHICH THIS EQUIPMENT IS UTILIZED.

THIS PRODUCT MAY BE SUBJECT TO THE JURISDICTION OF THE U.S. WIRE AND COMMUNICATIONS ACT (18 UNITED STATES CODE §§ 2510-2522) (HEREINAFTER REFERRED TO AS "ACT") REGARDING SURREPTITIOUS RECORDING DEVICES. THE USES OF SUCH PRODUCTS ARE REGULATED BY THE ACT. ADDITIONALLY, THE LAWS OF SOME STATES, COUNTIES, CITIES OR LOCALITIES MAY PROHIBIT THE POSSESSION AND/OR USE OF THIS OR SIMILAR PRODUCTS. IT IS THE RESPONSIBILITY OF THE RETAIL BUYER AND/OR FINAL CONSUMER (HEREINAFTER REFERRED AS "BUYER") TO ASCERTAIN, UNDERSTAND, AND OBEY ANY AND ALL APPLICABLE LOCAL, STATE, AND FEDERAL LAWS REGARDING POSSESSION AND USE OF THIS PRODUCT. BY PURCHASING THIS PRODUCT THE BUYER REPRESENTS THAT IT WILL INDEMNIFY THE MANUFACTURER AND/OR DISTRIBUTOR AND HOLD THEM HARMLESS FOR ANY POSSESSION, USE AND/OR MISUSE THAT VIOLATE ANY FEDERAL, STATE OR LOCAL LAW OR REGULATION REGARDING AUDIO AND/OR VIDEO DEVICES. BUYER AGREES TO CONSULT WITH AN ATTORNEY AT LAW REGARDING POSSESSION OR APPROPRIATE USE OF A COVERT DEVICE. NOTE THAT LAWS AND REGULATIONS VARY FROM STATE TO STATE. IF BUYER EXPORTS THIS PRODUCT, THE BUYER WILL COMPLY WITH US EXPORT CONTROL LAWS AND ANY APPLICABLE DEPARTMENT OF COMMERCE, STATE AND TREASURY REGULATIONS GOVERNING EXPORTS AND SALES TO PROHIBITED END USERS. DIVERSION OR RE-EXPORT CONTRARY TO U.S. LAW IS PROHIBITED. BUYER SHALL COMPLY WITH ALL APPLICABLE FEDERAL, STATE, AND LOCAL LAWS AND REGULATIONS GOVERNING THE SALE OF THIS PRODUCT, INCLUDING U.S. EXPORT CONTROL LAWS AND THE U.S. DEPARTMENT OF COMMERCE AND TREASURY REGULATIONS GOVERNING SALES TO PROHIBITED END USERS.

**PART 15 LOW POWER:** ANY CHANGES OR MODIFICATIONS TO THIS EQUIPMENT WITHOUT THE EXPRESS AUTHORIZATION OF THE MANUFACTURER COULD VOID THE USER'S AUTHORITY TO OPERATE THIS EQUIPMENT(RULE 15.21 OF THE FCC).

THIS EQUIPMENT HAS BEEN TESTED AND HAS BEEN FOUND TO BE IN COMPLIANCE WITH THE LIMITS FOR A CLASS B DIGITAL DEVICE, PURSUANT TO PART 15 OF THE FCC RULES. THESE LIMITS ARE DESIGNED TO PROVIDE REASONABLE PROTECTIONS AGAINST HARMFUL INTERFERENCE IN A RESIDENTIAL INSTALLATION. THIS EQUIPMENT USES, GENERATES AND CAN RADIATE RADIO FREQUENCY ENERGY AND IF NOT INSTALLED AND USED IN ACCORDANCE WITH INSTRUCTIONS, MAY CAUSE HARMFUL INTERFERENCE TO RADIO COMMUNICATIONS.