



## User Manual

Thank you very much for your purchasing DS 100.  
Please read this user manual before using in order to use it proper way.  
Also please keep this user manual and guarantee carefully .

Please utilize “Summary of user manual” for using DS 100 after you will  
become familiar with this user manual .  
Especially you must read and understand P.07 “Cautions”.

## Contents

### Before using the product

Characteristics of DS 100	-----	p.03
Function of DS100	-----	p.04
Composition of the product	-----	p.06
Cautions	-----	p.07
Name of each part	-----	p.09

### How to use

Need to know in use	-----	p.12
Use of battery and adaptor	-----	p.13
Detecting wireless tapping device	-----	p.14

Detecting wireless camera	-----	p.15
---------------------------	-------	------

Telephone tapping detection and prevention	-----	p.16
--	-------	------

Detecting laser tapping	-----	p.18
-------------------------	-------	------

Detecting wired camera	-----	p.19
------------------------	-------	------

Preventing tapping	-----	p. 20
--------------------	-------	-------

Product specification	-----	p. 21
-----------------------	-------	-------

Product warranty and A/S guide	-----	p. 22
--------------------------------	-------	-------

# Characteristics of DS 100

## Providing various detection and protection functions with one product



- ⊙ Detecting wireless tapping device
- ⊙ Detecting wireless camera
- ⊙ Detecting wired camera
- ⊙ Detecting wire telephone tapping on cable
- ⊙ Detecting wire telephone tapping
- ⊙ Detecting key-phone tapping
- ⊙ Detecting tapping device for vehicles
- ⊙ Detecting vehicle position finder
- ⊙ Detecting laser tapping
- ⊙ Detecting tapping device in internet phone and IP phone
- ⊙ Preventing wire line telephone tapping
- ⊙ Preventing laser tapping

## State Indicating Window

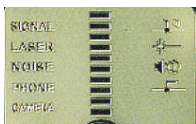

The device is convenient to use because it is designed to view all information at a glance such as Reception Sensibility Indication Window that shows tapping devices positions, each detection mode and warning signal lamps for each detection mode that indicate state of tapping

## Reception Sensibility Indication

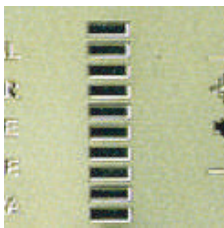

DS-100 indicates position of wireless tapping devices, hidden camera, etc. with the 10 levels of colored LED through Level 1 to Level 10 reflecting the distance where they are located. Supposing that distance to the position of wireless tapping devices, hidden camera, etc. is within 1~6 m, then the device provides function to find out them as following: user can set the indicating levels of device to indicate Level 1 when approaching at/within 6 m, means first detect tapping and to indicate Level 10, the maximum level, when approaching within 1m. And then user can find out the position of them correctly and error by checking change of indication Level

## Easy Handling and Operation

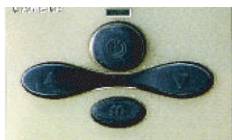

⊕ Power switch On/Off by button 5 stages of detection mode change by one button Increase and decrease volume by button are available and so user can operate it with easy and convenience

## Function of DS100

### Detection Function



In order to detect tapping devices using various types of wireless transmission, DS100 receives broadband signals of wavelength from 10MHz to 8GHz and indicates the reception sensibility from Level 1 to Level 10. Therefore it can provide to user correct information about existence of tapping devices together with their locations.

Function to detect wireless tapping device

Function to detect wireless camera

Function to detect wire telephone tapping, key-phone tapping and tapping device inside Internet phone/IP phone

Function to detect tapping device for vehicles and vehicle position finder

### Tapping Prevention Function



As it is a preventing method using white noise, DS-100 extracts only white noise from frequency band generated by noise generator through frequency band filter and generates continuous and even sound of 40~50 dB that its frequency band is most comfortable for human beings to hear. The tapping prevention function can be used for noise interception as well.

Preventing laser tapping

### Telephone Tapping Detecting and Preventing Functions



When using DS-100, it is connected to wire telephone of user through its telephone terminal at side and it can detect tapping devices installed on telephone wire. Also it can detect tapping by illegally bridged telephone and illegal use of bridged telephone, and it provides the function to prevent illegal use of bridged telephone.

Function to detect Wire Telephone Tapping on cable

Function to prevent Wire Telephone Tapping on cable

### Laser Tapping Detecting Function



The laser tapping device shoot the laser or infrared rays to the tapping object through the window from outside building or car. In this case, it receive the vibration of window and analyze it to be converted into voice substitution for tapping. DS-100 can detect its tapping device by checking the expected direction of window by its sensor





The detector of the wired camera is made by utilizing the principle which camera lens is reflected from the LED.  
If DS-110 detect closely the suspicious area of wired camera's location ( by DS-110 lens), the lens of wired camera will reflect the light. Also, it can be confirmed by eyes.

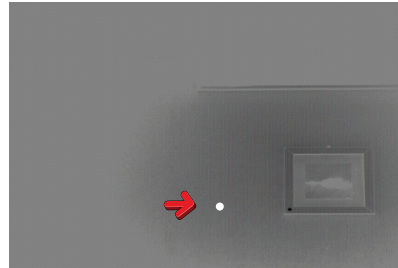
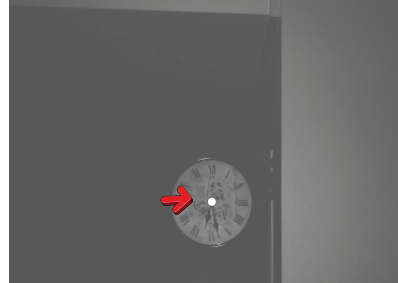

Composition of the product

In the product package, there are such components shown below , please check.



DS100  
Main body



DS110  
Main body



Dedicated  
Adaptor



Dedicated  
Strap



9V  
Drycell



Telephone  
cables  
2 sets



earphone



Telephone  
cable  
connector

How to connect strap



## Cautions

Please certainly read The "User Manual" before using the product.



The product is designed in due consideration for stability . However, improper use of the product can be lead to accident due to fire and electric shock, etc. Therefore, please read the "User Manual" sufficiently before using the product in order to prevent such accident beforehand. Also, when handling product box, user manual and parts, please be careful to avoid hand injury.

In the case of product trouble



1. If there is abnormal smell and/or smoke ,:
  - a. Remove battery immediately.
  - b. Disconnect immediately if the product is connected to AC adaptor, DS-110 and/or other peripheral devices .
  - c. Contact our Customer Service Center immediately (See page 00-00).
2. Use only dedicated devices.  
Use only dedicated adaptor for DS-100 main body. Never use any other adaptor except dedicated one for DS-100.
3. If the product does not operate properly , please refer to the "Checking point before asking A /S" on page 23.

When using earphone



When you using earphone during the use of product, if you continue to use it for a long time with loud volume , indisposed condition may occur on your ears. Please use with proper volume for the area to search tapping . If you feel such abnormal symptoms like buzzing in the ears , please stop using the product and if such symptoms continue , contact doctor and take proper treatment.

If you want to use earphone, change mode first and do not change mode during you use earphone.

In the case of mode change during the use of earphone, there may intermittent crashing sounds . Such phenomena may occur in laser mode and it is not disorder on product but it is caused by detecting lights of illuminators around and converting them into sounds when the function is changed to laser mode.

Storage and handling of product

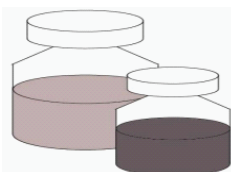
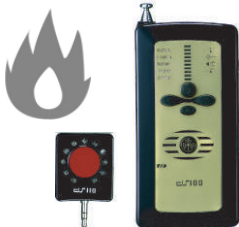
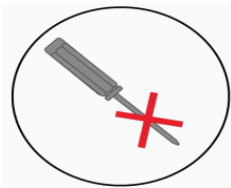

1. Do not throw into fire or heat the product and do not use or store around heating devices like electric heater . If there is battery inside , it may be burst and cause fire , injury and disorder . Also when it was wetted by accident , do not dry with heating devices like stove , heater , dryer, microwave oven, etc. Such heavier may cause serious disorder on product .
2. Disassembly and alteration is strictly forbidden . Never disassemble, alter or repair by yourself arbitrarily .
3. When you dispose main body or AC adaptor, never try burning as it is very dangerous, but dispose it subject to the waste disposal regulation of your residential district . If there is battery inside , remove it and dispose separately subject to waste disposal regulation .
4. Remove battery from the product and store separately if you do not use it for a long time.
5. Do not insert antenna or battery cover into mouth . It may cause injury .
6. Do not apply strong shock on product. It may cause damage on product or injury on you.
7. Do not keep in trousers pocket , may cause damage on product due to strong stress and lead to injury on you .
8. Be careful not squeeze your finger between battery cover and case , may cause injury .
9. Do not clean the product with organic solvents like thinner , benzene, alcohol, etc. In the case that main body and /or AC adaptor become dirty, just clean with dry clothes . If you clean with such organic solvents , it may cause damage on plastic and discoloration on front part .
10. Assure to put in antenna when carrying or storing the product . If you carry the product in the bag with the antenna unfolding , may cause disorder. Do not bend or curve antenna by force .
11. If AC adaptor is connected, do not touch main body during there is thunder and lightning . May cause electric shock due to falling of thunderbolt .



12. Keep main body and/or AC adaptor away from wetting by liquid and contamination with foreign material . Also be careful not to throw into water and to avoid touch with wet hands . If the inside of product is contaminated with water or foreign material , switch off, remove battery and/or disconnect AC adaptor immediately , and then contact our Customer Service Department shown on page 23. If you continue to use during the product is wet and /or contaminated , may cause serious troubles like fire, electric shock , and/or disorder.
13. Use dedicated telephone connection cable provided by the company .
14. Store in the place away from children and petty animal to touch . If the device may drop to cause injury and /or children may be injured by the antenna on eye or ear by mistake during touching it .

### Cautions in using AC Adaptor

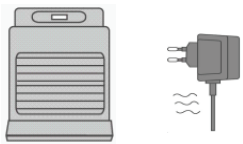
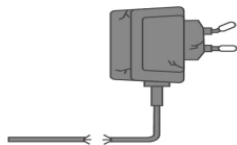

1. Do not use AC Adaptor that has damage on cable.
2. Do not step on AC Adaptor body and cord or pull or bend by force them.
3. Do not place AC Adaptor cord close to stove or heater , and do not heat it up.
4. Do not alter or damage AC adaptor body and cord arbitrarily by yourself.
5. Be careful not apply too strong force on AC adaptor cord (especially the connection part).
6. Be careful to avoid cord entangled when storing AC adaptor .
7. Insert AC adaptor plug into socket correctly .
8. When disconnect AC adaptor plug from socket, hold AC adaptor body and pull back straitly .
9. If not using for a long time, be sure to disconnect AC adaptor from socket.
10. Do not connect too many plug on one socket and never connect over nominal capacity .
11. Remove dirt on AC adaptor plug periodically with dry clothes .

### When using DS110







1. When you connect DS110 to DS100 main body for wired camera detection , be sure to connect after switch off DS100, and then switch on DS100 after connecting DS110.
2. After using, be sure to switch of DS100 before disconnecting DS110.
3. Do not gaze at the DS110 front LED when using DSi10. It may cause temporary affect on eye.
4. Do not connect DS110 terminal to other devices. It may cause disorder on DS110 and the devices.
5. When using DS110, use it in the direction as shown in the left figure and observe with naked eye.
6. Clean the middle lens part of DS110 with dry clothes before use.

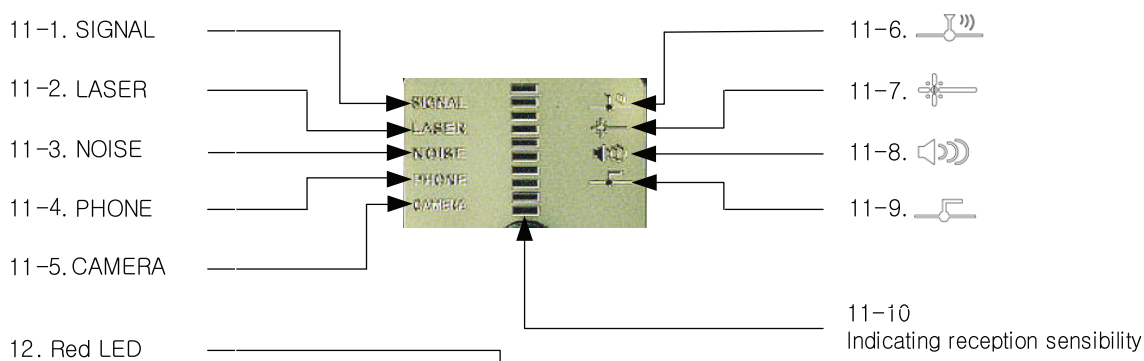
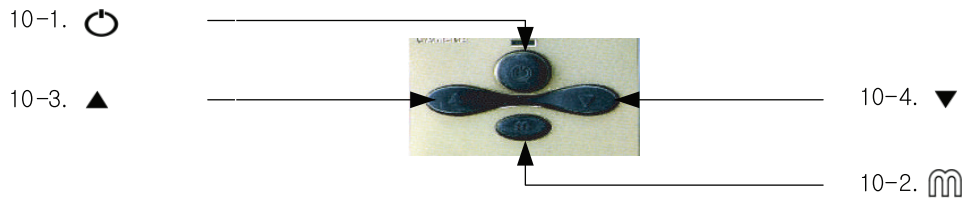





Name of each part



## Name of Each Part

- |   |  |
|---|--|
| 1. Antenna  | Antenna for receiving wireless signal When using the device, pull out as much as possible.   |
| 2.       | DS110 connection terminal for detecting wired hidden camera.   |
| 3. Laser sensor   | Laser sensor to detect the signal caused by laser tapping.   |
| 4. Strap linker   | Strap linker that can be connected with dedicated strap bundled together and /or other strap on the market   |
| 5.       | Earphone jack for plugging dedicated earphone for DS100 bundled together to hear sound occurring when the device is on detection mode.   |
| 6. TEL IN/TEL OUT   | Telephone cable connection terminal for connecting bundled telephone cable to the device in order to detect tapping . Remove rubber cover before use.  |
| 7. DC9V   | Power inlet terminal for connecting dedicated AC adaptor for DS100 bundled together . Use AC adaptor when you need to use the device for a long time such as for detecting tapping devices on cable / preventing tapping , etc.  |
| 8. Battery cover  | When you need to insert/change 9V battery, open this cover .<br>Be sure to use 6F22 (Manganese battery) or 6LF22 (Alkaline battery) rated product and 6LF22 (Alkaline battery) is recommended for long period use.   |
| 9. Speaker  | Built-in speaker to output sound during the device id on detection mode .  |
| 10. Control button  |  |
| 10-1.  | Main power button for switch ON/OFF DS100 main body .<br>ON: Press button for 3 seconds continuously .<br>OFF: Press button for 2 seconds continuously .   |
| 10-2.  | Button for changing detection mode . Detection mode is changed one by one in order whenever you press button.  |
| 10-3. ▲   | Volume control button to increase volume of speaker or earphone .  |
| 10-4. ▼   | Volume control button to decrease volume of speaker or earphone.   |
| 11. State Indicating Window   |  |
| 11-1. SIGNAL  | Wireless tapping device detection mode .<br>Used for detecting wireless tapping device, wireless tapping device with VOX function, wireless camera, wire telephone tapping device , key-phone tapping device , tapping device of inside internet phone/IP phone, tapping device for vehicle, vehicle position finder, etc. |
| 11-2. LASER   | Laser tapping device detection mode . Used for detecting laser tapping device .  |
| 11-3. NOISE   | Tapping prevention mode .<br>Used for preventing wire/wireless tapping, laser tapping, recording by voice recorder, recording by tape recorder , tapping by parabolic reflector , tapping by hidden tapping device in wall.  |



- 11-4. PHONE Mode for detection and prevention against tapping device installed on telephone line cable. Used for detecting and preventing wire telephone tapping device on cable and illegally bridged telephone on wire telephone .
- 11-5. CAMERA Wirer camera detection mode. Used for detecting wired camera
- 11-6.  Warning lamp lighted on when the device approached the position closest to tapping device on "SIGNAL" mode and "PHONE" mode.
- 11-7.  Warning lamp lighted on when some sound is output through speaker or earphone. Increase volume in the case that you cannot hear sound through speaker or earphone during this lamp is ON.
- 11-8.  Warning lamp lighted on when detecting the illegally bridged telephone on wire telephone line .
- 11-9.  Warning lamp lighted on when detecting laser tapping device .
- 11-10. Indicating reception sensibility  
Indicating/warning lamps composed of 10 levels reflecting the distance to wireless tapping devices, hidden camera, etc. and each lamp between Level 1 to Level 10 is lighted on dependent on the distance to tapping device . Supposing that distance to the position of wireless tapping devices , hidden camera, etc. is within 1~6 m, then the device lights on Level 1 when approaching at/within 6 m, means first detects tapping and lights on Level 10 LED, the maximum level , when approaching within 1m. And so user can find out the position of tapping device correctly through trial and error by checking change of indication Level and remove them .
12. LED LED lamp which is necessary for detecting wired camera
13. Strap linker It is already connected with strap when you purchase the device and if you want, you can connect other straps on the market.
14. Connection terminal Connection terminal for connecting DS110 to DS100 main body when you want to detect wired camera.
15. Lens Lens that is used for verifying camera lens with naked eye when you search wired camera lens.

## How to use

### 1. Need to know in use

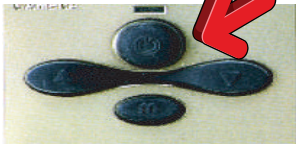
#### 1. Power ON and OFF of DS100



Power ON : Press "  " button for 3 seconds continuously .  
Power Off : Press "  " button for 2 seconds continuously .

\* Once you power on DS100 by pressing "  " button , then it displays 6 modes one by one in order and checks functions automatically whether there is any abnormality or not .

#### 2. How to change mode

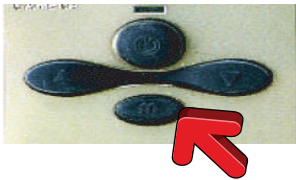
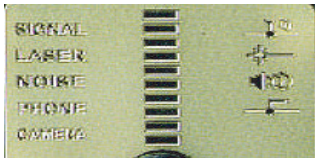

During power is ON, mode is changed one by one in order whenever you press "  " button .

#### 3. Adjusting volume

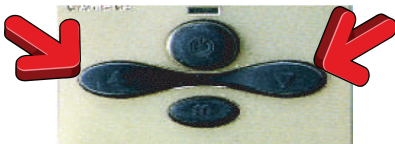

In order to adjust volume for speaker or earphone bundled together ;

▲ : Press button continuously , or .  
▼ : Press button continuously .

#### 4. Preparation items before using

1. When detecting on SIGNAL mode or SOUND mode  
Please turn off such devices that cause lot of electromagnetic waves or use electric wave like microwave oven, air cleaner, chandelier (using three wavelengths lamps), electrical heating floor, wireless phone, etc. As the product is designed to detect tapping signals in the frequency band of 10MHz - 8GHz, you need to turn off such devices that cause strong electromagnetic waves like microwave oven, air cleaner, electrical heating floor, etc. before start tapping. Also you need to turn off chandelier using three wavelengths lamps because it usually emits lot of electromagnetic waves.  
Especially wireless phone can be tapped without wireless tapping device , but only through catching the frequency used by it at remote place and so it is highly recommended not to use wireless phone.  
If you tried detection with such devices turned on, like microwave oven, air cleaner, chandelier, electrical heating floor or wireless phone, it may cause same effect as tapping devices during detection on SIGNAL mode or SOUND mode. Therefore you need to try again after turning off these devices.



## How to use

### 2. Use of Battery and Adaptor

#### 1. Low voltage warning lamp



Until the battery in use maintains normal condition, it lights blue color , however , if the capacity of battery becomes weak, it turns to blinking blue and red color .  
In this case you need to replace battery according to "2. How to replace battery".

After red lamp was turned on, the device may continue operation around one hour . However, there may be some negative effect on performance and so it is recommended to replace battery within 30 minutes.

#### 2. How to replace battery



In order to open the battery cover , first press on it and push it down to arrow direction.  
In order to close the cover , put the cover into the guide groove correctly and push it up.

Connect the battery terminal and battery holder to engage each other .

Sponge is adhered on battery cover in order to avoid battery moving . Do not remove it by force.

#### 3. Use of adaptor



Plug in dedicated adaptor for DS100 to power socket and then connect DC cord to DC 9V inlet terminal.

Even if battery is inserted in DS100, due to the built-in protection circuit, external adaptor can be used without problem .

DS100 does not provide recharging function.

Use dedicated adaptor for DS100 only.

Please refer to P.08 Need to know in use

## How to use

### 3. Detecting wireless tapping device



Used for detecting wireless tapping device, wireless tapping device with VOX function, wire telephone tapping device, tapping device of inside internet phone/IP phone, tapping device for vehicle, vehicle position finder. In the case of detecting tapping device for vehicle or vehicle position finder, do it with the vehicle engine running.



During the detection, turn off such devices that cause lot of electromagnetic waves or use electric wave like microwave oven, air cleaner, chandelier (using three wavelengths lamps), electrical heating floor, wireless phone, etc.

Please refer to P.12 Need to know in use

1. Pull out antenna as much as possible.



Pull out antenna of DS100 to the arrow direction as much as possible.

2. Power on DS100

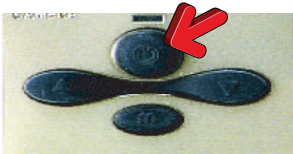

 : Press button for 3 seconds continuously.

Please refer to P.12 Need to know in use

3. Conversion to signal mode

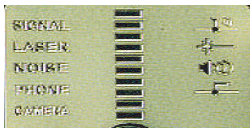

Convert to SIGNAL mode by pressing "SIGNAL" button.

(Once DS100 is powered on, it displays 6 modes one by one in order and checks functions automatically whether there is any abnormality or not, and after then returns to the first mode, SIGNAL mode.)

4. Searching tapping device



Search the area where you have doubt that there may be wireless tapping device with DS100 slowly by adjusting antenna direction.

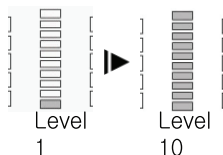

Through checking the reception sensibility indication lamps, move toward to the direction of antenna when sensibility level becomes higher.

(Supposing that distance to the position of wireless tapping devices, etc. is within 1~6 m, then the device lights on Level 1 when approaching at/within 6 m, means first detects tapping and lights on Level 10 LED, the maximum level, when approaching within 1m.)

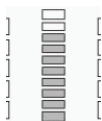

If sensibility level becomes above Level 8, "SIGNAL" is lighted on state indication window and if sensibility becomes Level 10, tapping device may be around that area. And then, therefore, you need to search that area with eye whether there is any doubtful electronic device.



In the case of wire telephone tapping device, key-phone tapping device, tapping device of inside internet phone/IP phone, some types are installed on cable but some are installed inside telephone. When detecting tapping device inside telephone, first hold on the handset of telephone and then search it by adjusting antenna direction to the telephone as shown in the figure in "4. Searching tapping device".

# How to use

## 4. Detecting wireless camera



Used for detecting wireless camera



During the detection, turn off such devices that cause lot of electromagnetic waves or use electric wave like microwave oven, air cleaner, chandelier (using three wavelengths lamps), electrical heating floor, wireless phone, etc.

Please refer to P.12 Need to know in use.

1. Pull out antenna as much as possible.



Pull out antenna of DS100 to the arrow direction as much as possible.

2. Power ON DS100

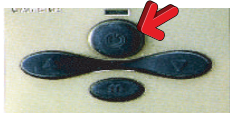

○ :Press button for 3 seconds continuously.

Please refer to P.12 Need to know in use

3. Conversion to signal mode

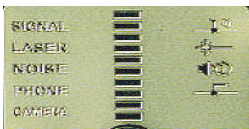

Convert to SIGNAL mode by pressing "  " button .  
(Once DS100 is powered on, it displays 6 modes one by one in order and checks functions automatically whether there is any abnormality or not, and after then returns to the first mode, SIGNAL mode.)

4. Searching tapping device



Search the area where you have doubt that there may be wireless tapping device with DS100 slowly by adjusting antenna direction .

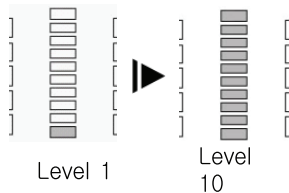

Through checking the reception sensibility indication lamps, move toward to the direction of antenna when sensibility level becomes higher .  
(Supposing that distance to the position of wireless tapping devices, etc. is within 1~6 m, then the device lights on Level 1 when approaching at/within 6 m, means first detects tapping and lights on Level 10 LED, the maximum level, when approaching within 1m.)



If sensibility level becomes above Level 8, "  " is lighted on state indication window and if sensibility becomes Level 10, tapping device may be around that area. And then, therefore, you need to search that area with eye whether there is any doubttable electronic device.



In the case of visual search with naked eye, first check whether there is pinhole lens or not.

## How to use

### 5. Telephone tapping detection and prevention



Use for detecting and preventing wire telephone tapping device on cable and illegally bridged telephone on wire telephone line . If the tapping device is installed on cable, it is possible to detect it installed within 100m as maximum.



During the detection, turn off such devices that cause lot of electromagnetic waves or use electric wave like microwave oven, air cleaner, chandelier (using three wavelengths lamps), electrical heating floor, wireless phone, etc.

Please refer to P.12 Need to know in use



It cannot be used for key-phone, internet phone/IP phone.

In the case of key-phone tapping device and tapping device of inside internet phone /IP phone, some types are installed on telephone cable but some are installed in inside telephone .

Please refer to P.14 How to use 3. Detecting wireless tapping device.



If you want to use DS100 as control type device for detection and prevention by connecting with telephone for a long time , use the dedicated AC adaptor bundled together.

1. Check and prepare 2 types of telephone cables and cable connector bundled together.



2. Disconnect the telephone cable from the telephone you want to search .

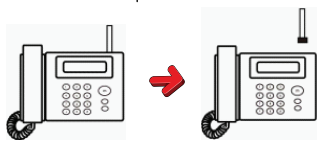

3. How to connect

Open the rubber cover on the side of DS100.

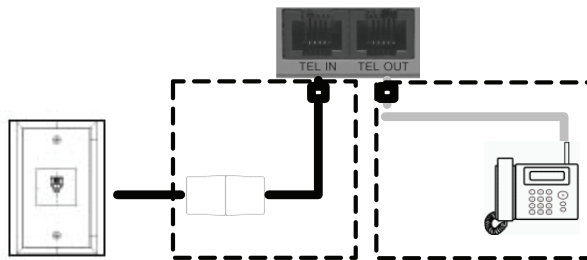

Connect the disconnected telephone cable in above step "2." to cable connector as shown in the picture. Connect the other end of the black cable which is connected to cable connector to the TEL IN terminal on the DS100 as shown in the picture.

Connect one end of the white cable to TEL OUT terminal on the DS100 and the other end to inlet terminal of the telephone that you disconnected in above step "2" in order to search.

(When connecting telephone cable, push the connecting plug into jack until there is the sound of "click". When disconnecting telephone cable, press locking latch and then pull out.





## How to use

### 4. Power ON DS100

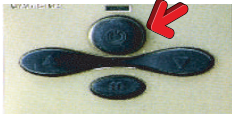

- : Press the button for 3 seconds continuously.  
Please refer to P.12 Need to know in use.

### 5. Conversion to PHONE mode

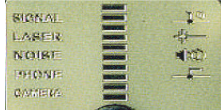

Convert to PHONE mode by pressing " ☎ " button .

### 6. Illegally bridged telephone detection and prevention

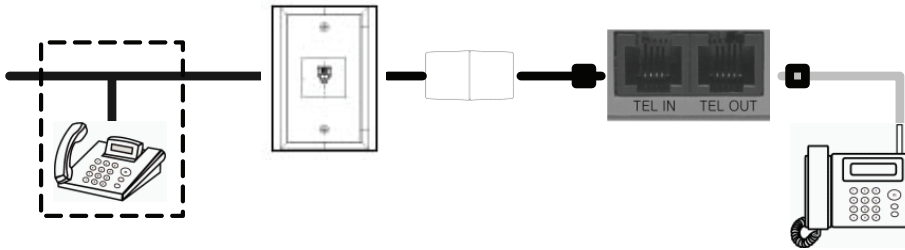

Connect DS100 same as the previous step 3.

In the case that a telephone is illegally bridged to a user's telephone line for the purpose of telephone tapping or illegal use of telephone , it can be detected and prevented from illegal use .

If the illegally bridged telephone is held on for tapping during the user 's telephone is in use, DS100 displays " ☎ " on the state indication window and sends warning sound to user's telephone , and also makes the bridged telephone unavailable to use .

If the illegally bridged telephone is held on for illegal use during the user 's telephone is not in use, DS100 displays " ☎ " on the state indication window and makes the bridged telephone unavailable to use .

## How to use

### 6. Detecting laser tapping



Used for detecting laser tapping.



During the detection, turn off such devices that cause lot of electromagnetic waves or use electric wave like microwave oven, air cleaner, chandelier (using three wavelengths lamps), electrical heating floor, wireless phone, etc.

Please refer to P.12 Need to know in use.

#### 1. Power On DS100

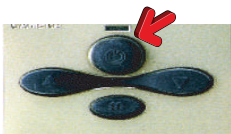

○ : Press the button for 3 seconds continuously.

Please refer to P.12 Need to know in use.

#### 2. Conversion to LASER

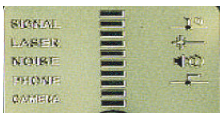

Convert to LASER mode by pressing "  " button.

#### 3. Searching tapping device

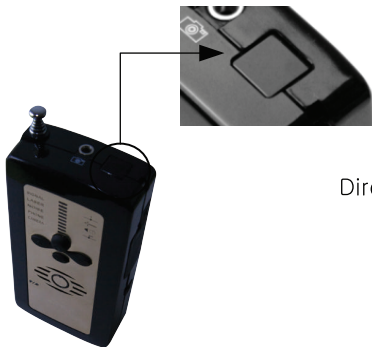

Direct the laser sensor of DS100 to face the window and then search tapping.

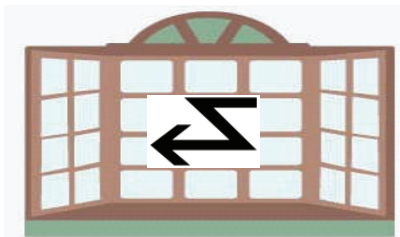

Search tapping through changing laser sensor direction according to arrow shown in the figure.

If laser tapping is detected, "  " is lighted on the state indication window and "toot-toot" sound is heard through DS100 speaker.



If you want to hear more clear sound, use the earphone bundled together.

Use the ▲▼ buttons for adjusting volume of speaker or earphone

Please refer to P.12 Need to know in use.

## How to use

### 7. Detecting wired camera



Used for detecting wired camera.



During the detection, turn off such devices that cause lot of electromagnetic waves or use electric wave like microwave oven, air cleaner, chandelier (using three wavelengths lamps), electrical heating floor, wireless phone, etc.



Please refer to P.12 Need to know in use.



When you connect DS110 to "📷" of DS100 main body be sure to connect after switch off DS100 .

Please refer to P.08 Cautions.



During you use DS110, highly bright LED is blinking. Do not gaze at it long time .

Please refer to P.08 Cautions.

1. Connect DS110 to "📷" of DS100 main body.

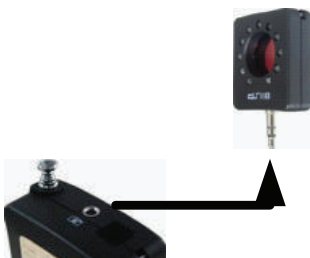

When you connect DS110 to "📷" of DS100 main body, be sure to connect it after switch off DS100 and as shown in the figure.

Please refer to P.08 Cautions.

2. Power ON DS100

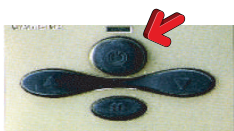

○ : Press the button for 3 seconds continuously .

Please refer to P.12 Need to know in use.

3. Conversion to CAMERA mode

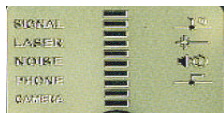

Convert to CAMERA mode by pressing "📷" button .

4. Searching tapping device

The basic method to use DS110 is to search pinhole lens of wired camera with naked eye through the red circular lens of DS110.



When you search pinhole lens through the red circular lens of DS110, direct the blinking LED to the direct to search, means opposite direction to eye. Observe through the lens at the back side of DS110 (where product specification is printed) with your eye close to it. In the case that lens is contaminated with foreign material, clean with dry soft clothes .

Observe the area where you have doubt that there may be wired camera, with naked eye through DS110 lens .

If there is wired camera you can visually verify the red spot reflected from pinhole lens through DS110 lens .

## How to use

### 9. Preventing tapping



Used for preventing tapping by wireless tapping device, wireless tapping device with VOX function, tapping device for vehicle, laser tapping device, voice recorder, tape recorder, parabolic reflector, hidden tapping device in wall, etc.



If you want to use DS100 as control type device for detection and prevention for a long time, use the dedicated AC adaptor bundled together.

#### 1. Power ON DS100

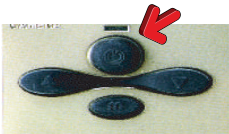

○ : Press the button for 3 seconds continuously.

Please refer to P.12 Need to know in use.

#### 2. Conversion to NOISE mode

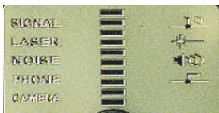

Convert to NOISE mode by pressing "  " button.

#### 3. Use for tapping prevention



When converting to NOISE mode, there occurs white noise sound "Sh" heard from DS100 speaker.

Adjust noise volume properly not to be harsh to ears so much. However, if the volume is louder, tapping prevent is better and more efficient.

When using for laser tapping prevention, place the device close to window and direct the speaker face to window.

During your conversation, please speak in lower as maximum.

## Specification

### DS100

Radio Frequency

- Gain : 20dB
- Response : 10MHz ~ 8GHz

Display :

- LED Bar Graph : LED supported by 10 level

Main Power Supply : 6LF22 Alkaline battery

Laser Reception

- 360°. Wavelength 720~1,050nm Laser Reception

Size : 114(L)X56(W)X28(H)mm

( Antenna Including 124(L)X56(W)X28(H)mm )

Weight : 114 gram, ( 160 gram including battery )

Dedicated Adaptor

- Input voltage : 95~130V, 200~275V. 50~60Hz
- Output voltage : DC 9V. 1000mA

### DS110

Frequency : 7.35Hz

ON-Time : 89.24mS / OFF-Time : 46.9mS

Size : 38×32×12mm

Input : DC 9V with 500mA

Current Draw : 96mA

## Product warranty and A/S Guide

### Product warranty

Dasol Engineering warrants that all DS100 products provided by Dasol Engineering and its dedicated distributors are free from defects in performance.

Dasol Engineering's principle warranty is policy to replace defective product with new one, at Dasol Engineering's discretion, subject to the term and condition below .

Warranty period may be changed dependent on the country where it was purchased, for more detail information regarding warranty period, please contact the distributor from whom you purchased the product .

Please be sure to keep the receipt of purchase during the warranty period in order to prove proper purchase of the product and warranty period.

If you want to receive any after service, please contact the official distributor from whom you purchased the product .

If after service for DS100 by the distributor is unavailable, send the product to Dasol Engineering via the distributor. When you send the product to Dasol Engineering, it must be packed same condition as you purchase it.

The followings are scope of warranty provided by Dasol Engineering:

If you find the product defective within the warranty period (in general 12 months from purchase date), sent it to Dasol Engineering Service Center via the official distributor together with receipt of purchase that proves proper purchase of the product and warranty period.

If within the warranty period the product is determined to be defective (at the date of original purchase) due to the responsibility of Dasol Engineering ,at Dasol Engineering's discretion, such as improper materials, workmanship or any other product defect itself, Dasol Engineering will, without any charge, replace the product or its defective parts subject to the terms and limitations below. Dasol Engineering may replace defective products or parts with new or refurbished products or parts at Dasol Engineering's discretion.

Scope of warranty maybe differ from purchase country and condition of returned product , and Dasol Engineering will confirm the scope of warranty to be applied for the product within two days after receiving the returned product, and will take required action, such as sending replaced product, within 4 days after confirming the scope warranty to be applied .

#### Terms

This warranty does not cover the following cases and actual cost may be applied for remedial action:

1. Serial no provided by manufacturer was changed or removed,
2. Product was not purchased from official distributor,
3. Product was damaged due to carelessness of user, accident, misuse, water-damage, arbitrary disassembly or alteration
4. Product disorder due to not following user manual such as improper operation, maintenance, and any other responsibility of user
5. Product damage due to act of god and disaster by nature
6. There is evidence to receive A/S or maintenance service other than Dasol Engineering's official distributors.
7. Accessories apart from DS100 main body and DS110. The accessories need to be purchased separately.

#### Limitation

In no circumstance, Dasol Engineering's obligation under this warranty will exceed to replace defective product with new one.

## MANUFACTURER

Dasol Engineering Company

Address : 1011-15, Doksan 1-dong Geumcheon -gu, Seoul, Korea